

SDM120CT-M(40mA)

Single-Phase Multifunction DIN Rail Meter



- Measures kWh, kVArh, KW, kVA, PF, Hz, dmd, V, A, etc.
- Bi-directional measurement IMP & EXP
- Two pulse outputs
- RS485 Modbus
- Din rail 35mm
- 40mA AC CT connection
- Better than Class 1 accuracy

User Manual V1.0

Application

The energy-meters are used to measure single-phase applications like residential, utility and Industrial. The unit measures and displays various important electrical parameters. It equipped with a white back-lighted LCD screen for prefect reading. As well as a RS485 communication port for remote reading and monitoring. Bi-directional energy measurement makes it a good choice for solar PV energy metering. The compact design and din rail installation provides an easy and economical solution for your metering demand.

PART 1 Specification

General Specifications

Voltage AC (Un)	230V
Voltage Range	176~276V AC
Base Current (Ib)	0.1V AC
Power consumption	<2W/10VA
Frequency	50/ 60Hz(±10%)
AC voltage withstand	4KV for 1 minute
Impulse voltage withstand	6KV-1.2uS waveform
Overcurrent withstand	20Imax for 0.5s
Pulse output 1	1000imp/kWh (default)
Pulse output 2	0.001(default) /0.01/0.1/1 kWh/kVArh (configurable)
Display	LCD with white backlit
Max. Reading	999999kWh

Accuracy

Voltage	0.5% of range maximum
Current	0.5% of nominal
Frequency	0.2% of mid-frequency
Power factor	1% of Unity
Active power	1% of range maximum
Reactive power	1% of range maximum
Apparent power	1% of range maximum
Active energy	Class 1 IEC62053-21 Class B EN50470-1/3
Reactive energy	Class 2 IEC62053-23

Environment

Operating temperature	-25°C to +55°C
Storage and transportation temperature	-40°C to +70°C
Reference temperature	23°C ± 2°C
Relative humidity	0 to 95%, non-condensing
Altitude	up to 2000m
Warm up time	3s
Installation category	CAT II
Mechanical Environment	M1
Electromagnetic environment	E2
Degree of pollution	2

Output

Pulse Output

The meter provides two pulse outputs. Both pulse outputs are passive type.

Pulse output 1 is configurable. The pulse output can be set to generate pulses to represent total /import/ export kWh or kVArh.

The pulse constant can be set to generate 1 pulse per: 0.001(default) /0.01/0.1/1 kWh/kVArh.

Pulse width: 200/100/60ms

Pulse output 2 is non-configurable. It is fixed to total kWh. The constant is 1000imp/kWh.

RS485 output for Modbus RTU

The meter provides a RS485 port for remote communication. Modbus RTU is the protocol applied. For Modbus RTU, the following RS485 communication parameters can be configured by the Modbus command.

Baud rate: 1200, 2400, 4800, 9600 bps. Default: 2400 bps

Parity: NONE/EVEN/ODD

Stop bits: 1 or 2

Modbus Address: 1 to 247



Mechanics

Din rail dimensions	18x118x64 (WxHxD) DIN 43880
Mounting	DIN rail 35mm
Ingress protection	IP51 (indoor)
Material	self-extinguishing UL94V-0

PART 2 Operation

Initialization Display

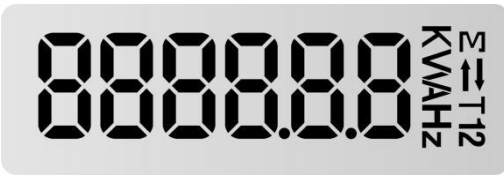
When it is powered on, the meter will initialize and do self-checking.



1		Full Screen It will last for 3 seconds.
2		Software version in kind prevail It will last for 3 seconds.









After the self-checking program, the meter display will show the total active energy (kWh)

Scroll Display by Button

There is a button on the front of the meter. After initialization and self-checking program, the meter display the measured values. The default page is total kWh. If the user wants to check other information, he needs to press the scroll button on the front panel.

	Click the button, the LCD display will scroll the measurements.
	Keep pressing the button for 3 seconds, the meter will get into set-up mode.

1		Total active energy (kWh) Display format: 0000.00→9999.99→10000.0→99999.9→000000→999999→0000.00
2		Import active energy (kWh) Display format: 0000.00→9999.99→10000.0→99999.9→000000→999999→0000.00

3		Export active energy (kWh) Display format: 0000.00→9999.99→10000.0→99999.9→000000→999999→0000.00
4		Voltage (V)
5		Current (A)
6		Active power (W)
7		Frequency (F)
8		Power factor (PF)
9		Modbus address (ID) Default: 001
10		Baud rate Default : 2400bps

11		Parity None/even/odd are optional Default: none
12		CT1 Primary current 5A-9999A Default: 5
13		Software Version in kind prevail

Note: Secondary voltage input is non-configurable, default is 40mA.

Set-up Mode

To get into Set-up Mode, the user need keep pressing the button for 3 seconds, the meter LCD will shows “-SET-”.



The user can program the meter parameters by sending correct command via RS485 port.
 The protocol is Modbus RTU. For the details. Please look at the “Eastron SDM120-CTM(40mA) protocol”.

Wiring Diagram

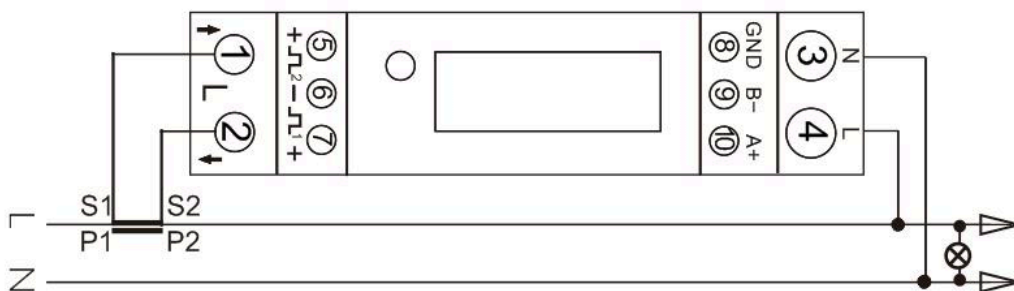

Dimensions

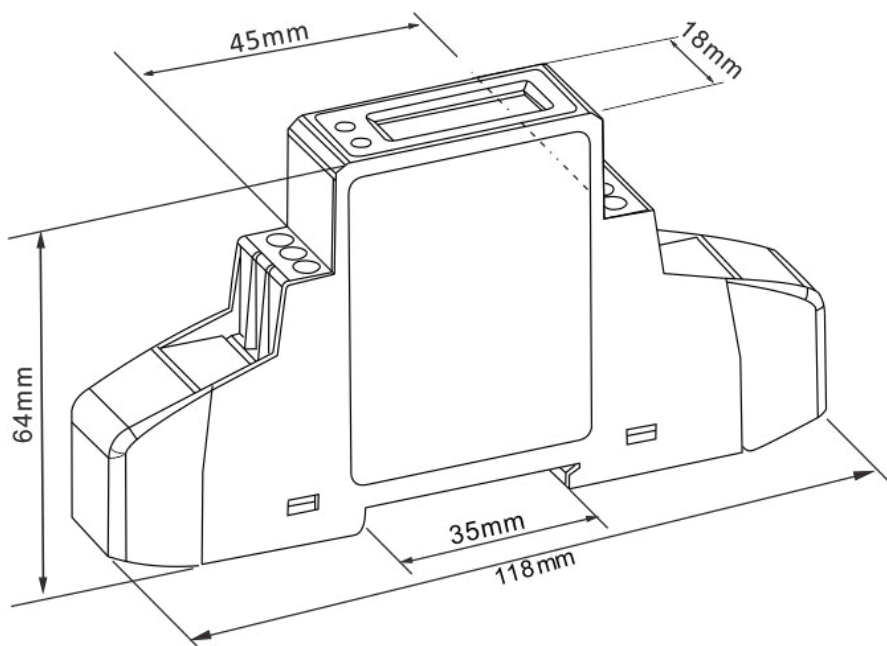

Installation

